

MATELOTS



MATELOTS

MATELOTS



MATELOTS

MATELOTS



MATELOTS

MÉDIANE



MÉDIANE

MÉDIANE



MÉDIANE

MATELOTS



MATELOTS

MATELOTS



MATELOTS

MATELOTS



MATELOTS

MÉDIANE



MÉDIANE

MÉDIANE



MÉDIANE

MATELOTS



MATELOTS

MATELOTS



MATELOTS

MATELOTS



MATELOTS

MÉDIANE



MÉDIANE

MÉDIANE



MÉDIANE

MATELOTS



MATELOTS

MATELOTS



MATELOTS

MATELOTS



MATELOTS

MÉDIANE



MÉDIANE

MÉDIANE



MÉDIANE

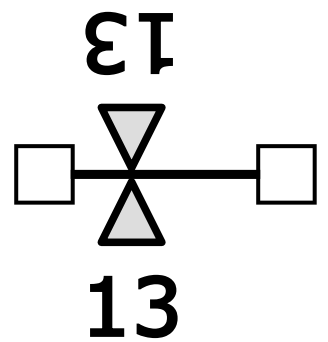
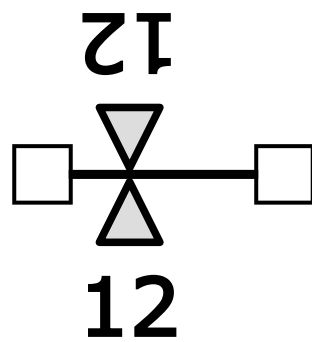
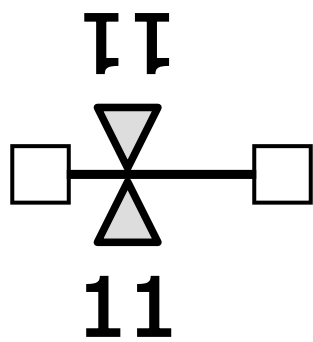
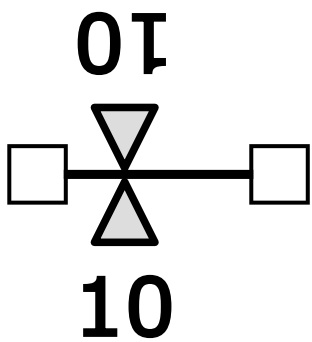
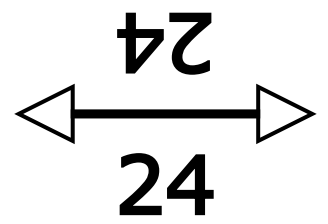
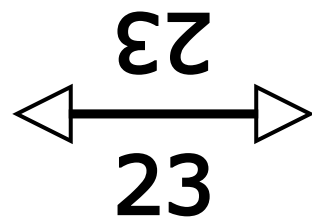
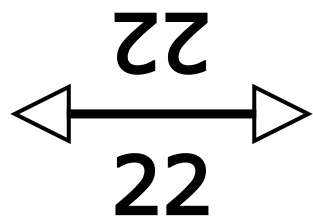
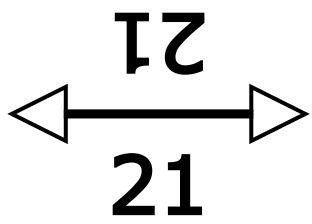
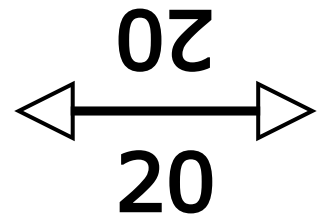
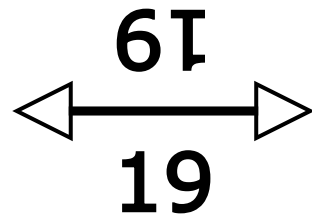
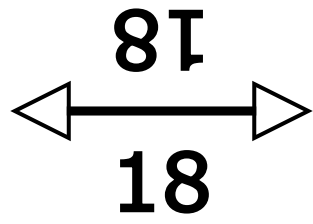
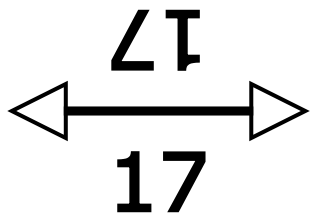
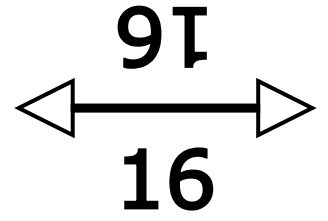
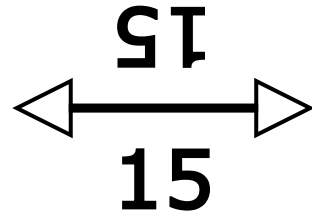
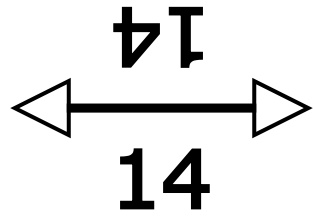
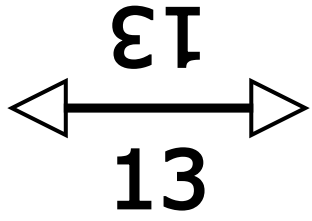
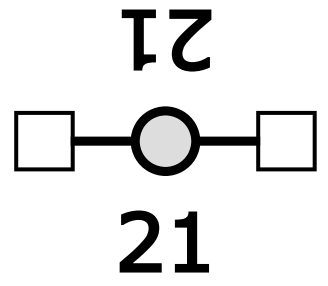
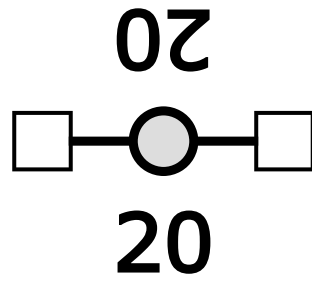
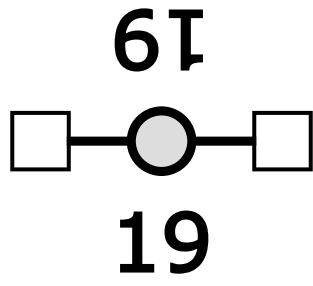
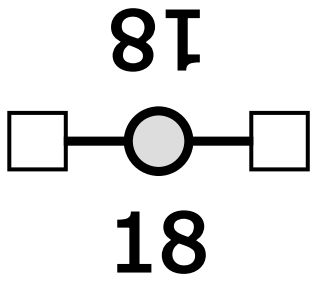

MÉDIANE



MÉDIANE

MÉDIANE



MÉDIANE

MÉDIANE



MÉDIANE

MÉDIANE



MÉDIANE

ÉTENDUE



ÉTENDUE

ÉTENDUE



ÉTENDUE

ÉTENDUE



ÉTENDUE

ÉTENDUE



ÉTENDUE

ÉTENDUE



ÉTENDUE

ÉTENDUE



ÉTENDUE

ÉTENDUE



ÉTENDUE

ÉTENDUE



ÉTENDUE

ÉTENDUE



ÉTENDUE

ÉTENDUE



ÉTENDUE

ÉTENDUE



ÉTENDUE

ÉTENDUE



ÉTENDUE

MOYENNE



MOYENNE

MOYENNE



MOYENNE

MOYENNE



MOYENNE

MOYENNE



MOYENNE

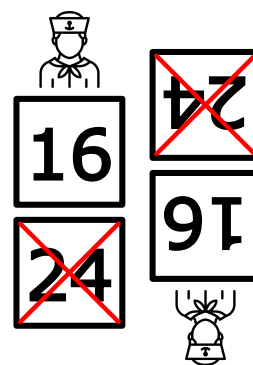
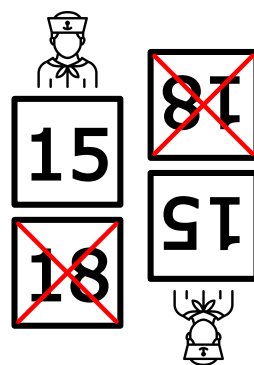
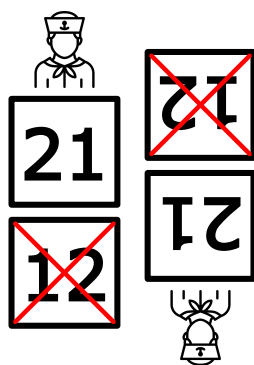
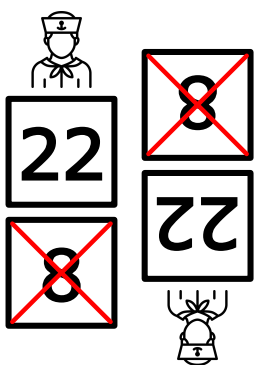
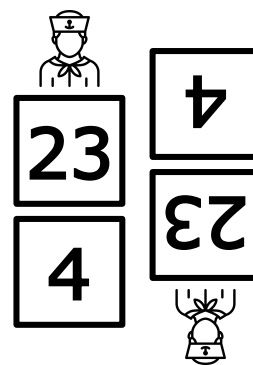
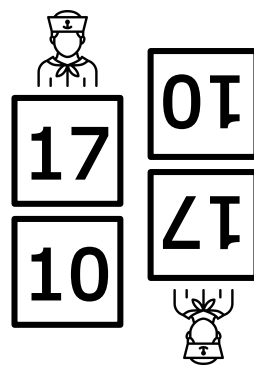
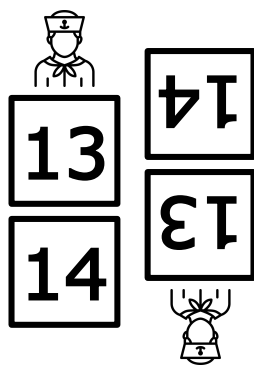
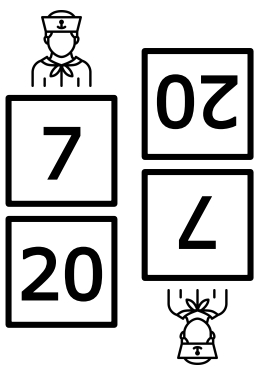
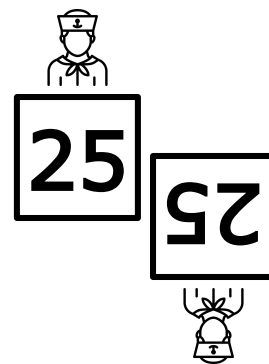
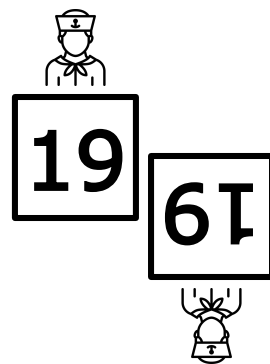
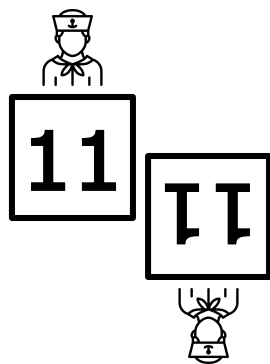
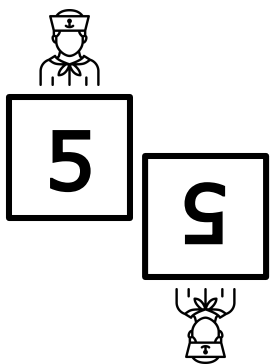
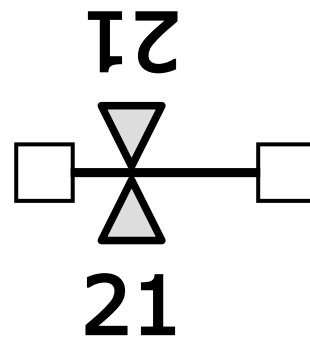
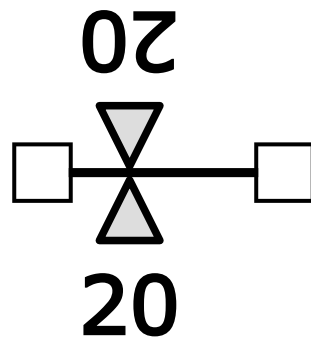
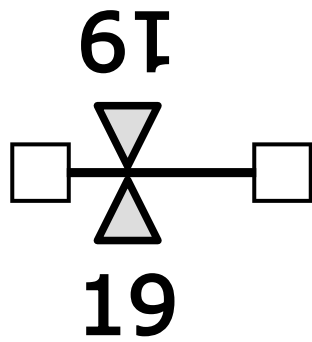
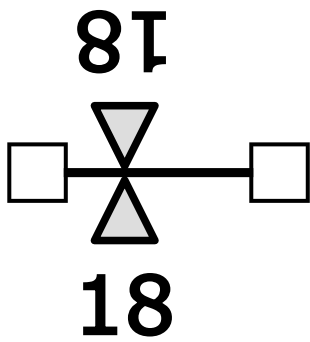
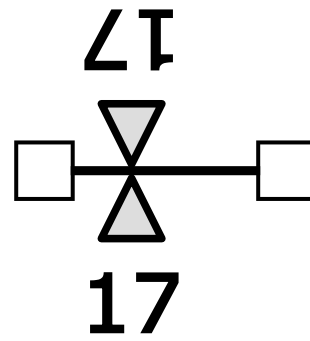
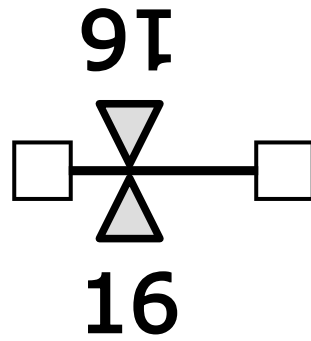
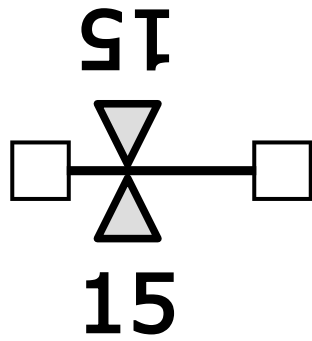
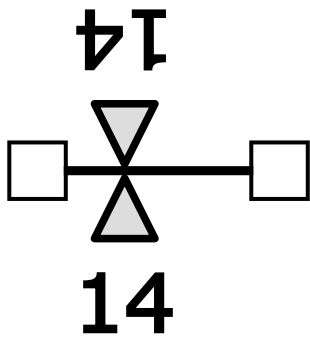

MOYENNE



MOYENNE

MOYENNE



MOYENNE

POSITION



POSITION

POSITION



POSITION

POSITION



POSITION

MOYENNE



MOYENNE

MOYENNE



MOYENNE

POSITION



POSITION

POSITION



POSITION

POSITION



POSITION

MOYENNE



MOYENNE

MOYENNE



MOYENNE

POSITION



POSITION

POSITION



POSITION

POSITION



POSITION

MOYENNE



MOYENNE

MOYENNE



MOYENNE

POSITION



POSITION

POSITION



POSITION

POSITION



POSITION

# STATISTANIC

# Feuille de marques

Joueur(s) : ..... / .....

Total :

<b>MANCHE #1</b>	Emplacements choisis :					
	MATELOTS	POSITION	ÉTENDUE	MÉDIANE	MOYENNE	Points
CONTRAINTES						
Validation <input checked="" type="checkbox"/> <input checked="" type="checkbox"/>	<input type="checkbox"/>	<input type="checkbox"/> 1 point	<input type="checkbox"/> 1 point	<input type="checkbox"/> 2 points	<input type="checkbox"/> 3 points	

<b>MANCHE #2</b>	Emplacements choisis :					
	MATELOTS	POSITION	ÉTENDUE	MÉDIANE	MOYENNE	Points
CONTRAINTES						
Validation <input checked="" type="checkbox"/> <input checked="" type="checkbox"/>	<input type="checkbox"/>	<input type="checkbox"/> 1 point	<input type="checkbox"/> 1 point	<input type="checkbox"/> 2 points	<input type="checkbox"/> 3 points	

<b>MANCHE #3</b>	Emplacements choisis :					
	MATELOTS	POSITION	ÉTENDUE	MÉDIANE	MOYENNE	Points
CONTRAINTES						
Validation <input checked="" type="checkbox"/> <input checked="" type="checkbox"/>	<input type="checkbox"/>	<input type="checkbox"/> 1 point	<input type="checkbox"/> 1 point	<input type="checkbox"/> 2 points	<input type="checkbox"/> 3 points	

<b>MANCHE #4</b>	Emplacements choisis :					
	MATELOTS	POSITION	ÉTENDUE	MÉDIANE	MOYENNE	Points
CONTRAINTES						
Validation <input checked="" type="checkbox"/> <input checked="" type="checkbox"/>	<input type="checkbox"/>	<input type="checkbox"/> 1 point	<input type="checkbox"/> 1 point	<input type="checkbox"/> 2 points	<input type="checkbox"/> 3 points	

<b>MANCHE #5</b>	Emplacements choisis :					
	MATELOTS	POSITION	ÉTENDUE	MÉDIANE	MOYENNE	Points
CONTRAINTES						
Validation <input checked="" type="checkbox"/> <input checked="" type="checkbox"/>	<input type="checkbox"/>	<input type="checkbox"/> 1 point	<input type="checkbox"/> 1 point	<input type="checkbox"/> 2 points	<input type="checkbox"/> 3 points	

<b>MANCHE #6</b>	Emplacements choisis :					
	MATELOTS	POSITION	ÉTENDUE	MÉDIANE	MOYENNE	Points
CONTRAINTES						
Validation <input checked="" type="checkbox"/> <input checked="" type="checkbox"/>	<input type="checkbox"/>	<input type="checkbox"/> 1 point	<input type="checkbox"/> 1 point	<input type="checkbox"/> 2 points	<input type="checkbox"/> 3 points	

<b>MANCHE #7</b>	Emplacements choisis :					
	MATELOTS	POSITION	ÉTENDUE	MÉDIANE	MOYENNE	Points
CONTRAINTES						
Validation <input checked="" type="checkbox"/> <input checked="" type="checkbox"/>	<input type="checkbox"/>	<input type="checkbox"/> 1 point	<input type="checkbox"/> 1 point	<input type="checkbox"/> 2 points	<input type="checkbox"/> 3 points	

<b>MANCHE #8</b>	Emplacements choisis :					
	MATELOTS	POSITION	ÉTENDUE	MÉDIANE	MOYENNE	Points
CONTRAINTES						
Validation <input checked="" type="checkbox"/> <input checked="" type="checkbox"/>	<input type="checkbox"/>	<input type="checkbox"/> 1 point	<input type="checkbox"/> 1 point	<input type="checkbox"/> 2 points	<input type="checkbox"/> 3 points	

<b>MANCHE #9</b>	Emplacements choisis :					
	MATELOTS	POSITION	ÉTENDUE	MÉDIANE	MOYENNE	Points
CONTRAINTES						
Validation <input checked="" type="checkbox"/> <input checked="" type="checkbox"/>	<input type="checkbox"/>	<input type="checkbox"/> 1 point	<input type="checkbox"/> 1 point	<input type="checkbox"/> 2 points	<input type="checkbox"/> 3 points	

<b>MANCHE #10</b>	Emplacements choisis :					
	MATELOTS	POSITION	ÉTENDUE	MÉDIANE	MOYENNE	Points
CONTRAINTES						
Validation <input checked="" type="checkbox"/> <input checked="" type="checkbox"/>	<input type="checkbox"/>	<input type="checkbox"/> 1 point	<input type="checkbox"/> 1 point	<input type="checkbox"/> 2 points	<input type="checkbox"/> 3 points	

<b>MANCHE #11</b>	Emplacements choisis :					
	MATELOTS	POSITION	ÉTENDUE	MÉDIANE	MOYENNE	Points
CONTRAINTES						
Validation <input checked="" type="checkbox"/> <input checked="" type="checkbox"/>	<input type="checkbox"/>	<input type="checkbox"/> 1 point	<input type="checkbox"/> 1 point	<input type="checkbox"/> 2 points	<input type="checkbox"/> 3 points	

<b>MANCHE #12</b>	Emplacements choisis :					
	MATELOTS	POSITION	ÉTENDUE	MÉDIANE	MOYENNE	Points
CONTRAINTES						
Validation <input checked="" type="checkbox"/> <input checked="" type="checkbox"/>	<input type="checkbox"/>	<input type="checkbox"/> 1 point	<input type="checkbox"/> 1 point	<input type="checkbox"/> 2 points	<input type="checkbox"/> 3 points	



# STATISTANIC

A large boat-shaped graphic containing 30 numbered boxes for data entry. The boxes are arranged in two rows of 15, numbered 1 to 30. A central vertical bar with four ovals is positioned between the two rows. The boat's hull is shaded with a stippled pattern, and an anchor is visible at the top.

# STATISTANIC

